

Installationsanleitung

CON-Line[®] W 55 - 65“ | Art.-Nr.: 2806

DE Installationsanleitung

GB Installation manual

FR Guide d'installation

NL Installatievoorschrift

ES Guía de instalación

SE Installationsanvisning

TR Yükleme Rehberi

RU инструкция по установке

CN 安装指南

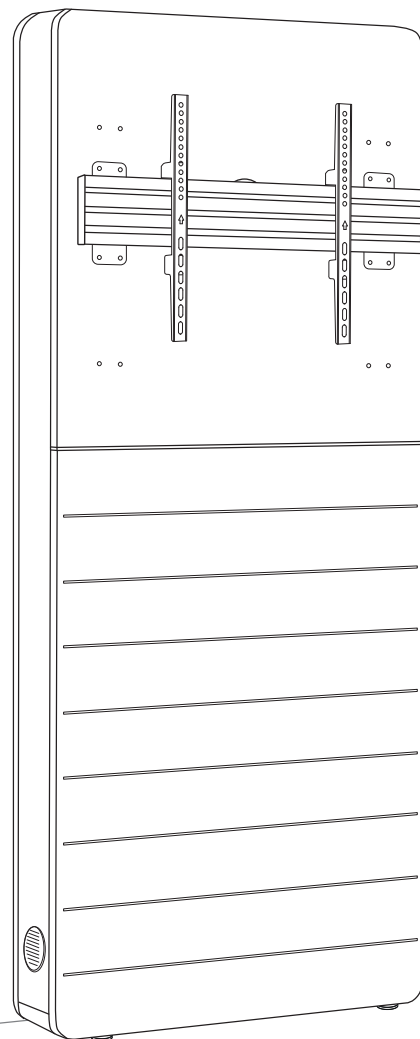

DE

Achtung!

Technische Geräte stellen einen beträchtlichen Wert dar. Sie sollten daher bei der Installation vorsichtig mit den Komponenten umgehen und diese bei Bedarf schützen.

Auch sollte, falls nötig, der Installtionsbereich abgesichert werden. Herabfallende Teile können zu Verletzungen und Materialschäden führen.

Die im Lieferumfang enthaltenen Materialien sind unter Umständen nicht für die speziellen Gegebenheiten am Installationsort geeignet. Bitte prüfen Sie dies vorab und ersetzen Sie diese bei Bedarf durch geeignete Materialien.

Falls Sie Bezüglich der Installation des Produkts unsicher sind oder noch Fragen haben wenden Sie sich an uns oder anderes ausgebildetes Fachpersonal.

GB

Caution!

Technical devices are of considerable value. You should therefore handle the components carefully during installation and protect them if necessary.

If necessary, the installation area should also be secured. Falling parts can cause injuries and material damage.

The materials included in the scope of delivery may not be suitable for the special conditions at the installation site. Please check this in advance and replace it with suitable materials if necessary.

If you are unsure about the installation of the product or have any questions, please contact us or other trained specialists.

Lieferumfang | Scope of delivery

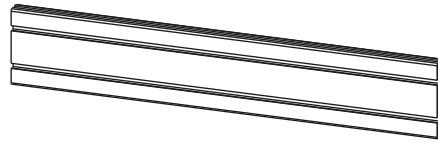
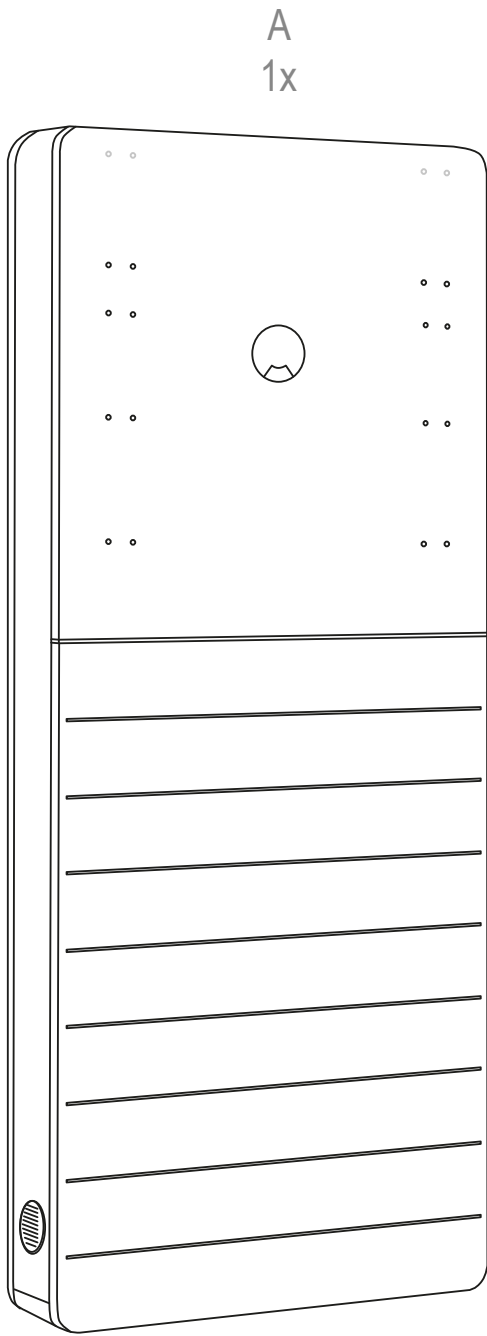

B
1x

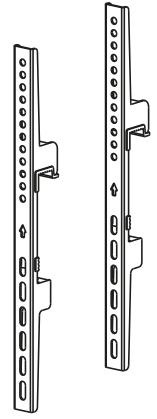

C
2x

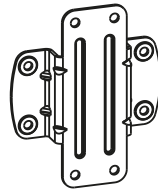

D
2x



E
2x



F
2x

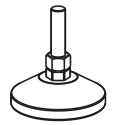

G
2x



H
2x
M8



I
2x
M8x10



J
8x
M8x12



K
10x



L
10x
4,0x16

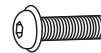

M
8x
M8x16

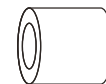

N
5x
15 mm

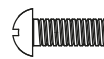

M-A
4x
M5x14

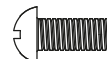

M-B
4x
M6x14



M-C
4x
M6x30

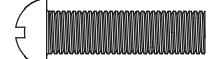

M-D
4x
M8x30

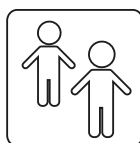
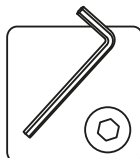

M-E
4x
M8x50

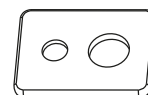

M-F
4x



M-G
8x

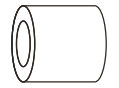

M-H
8x

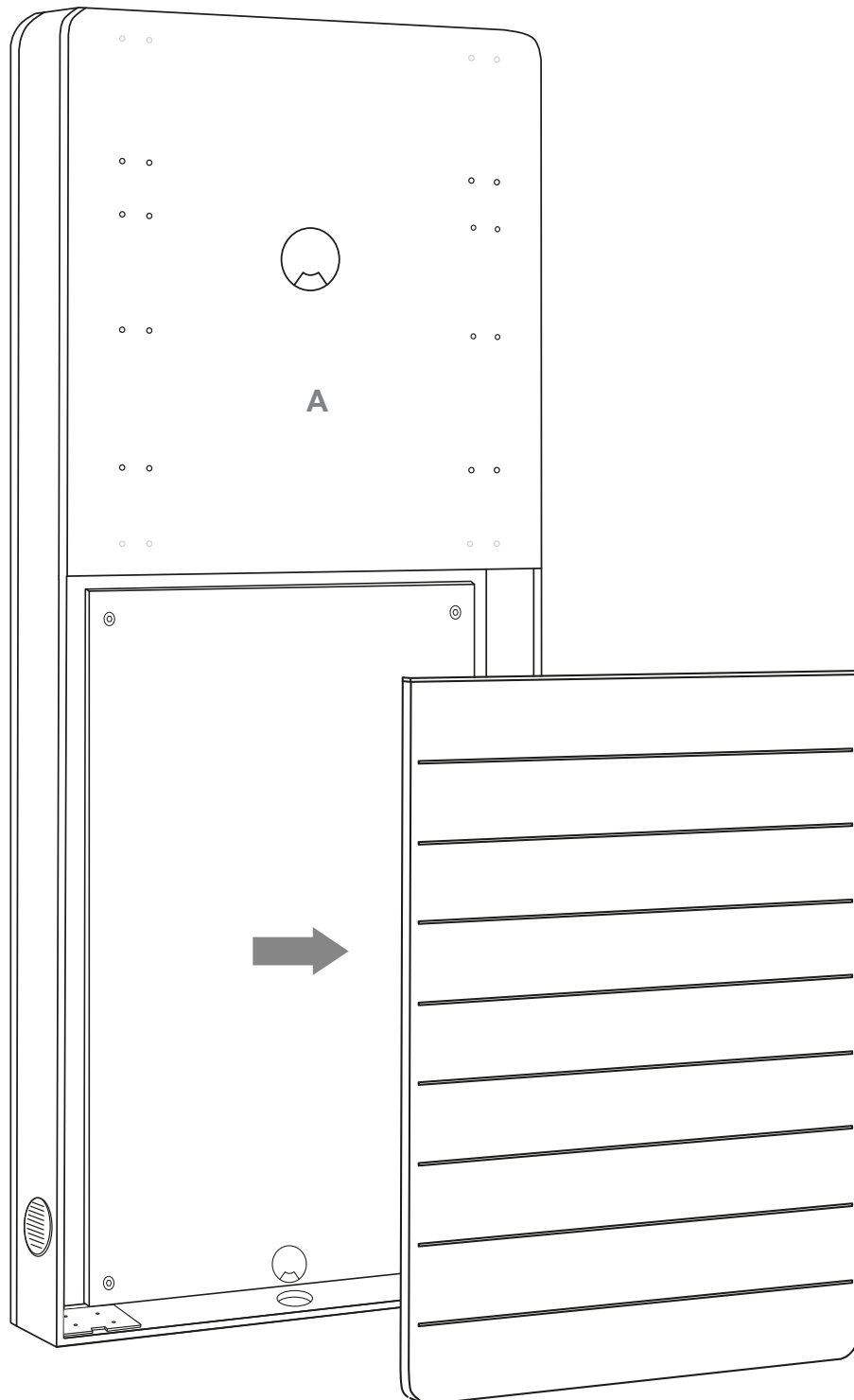

Nehmen Sie die Frontblende ab. Die Frontblende ist durch eine Magnetarretierung fixiert.

Take off the front panel. The front panel is fixed by a magnet lock.

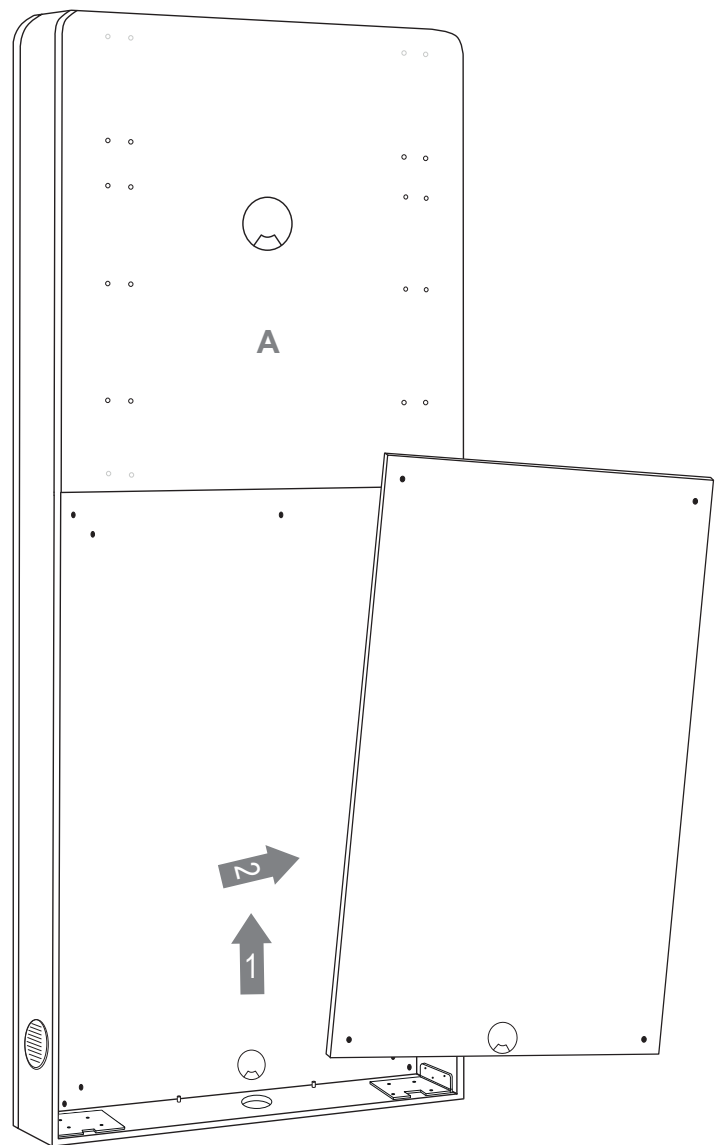
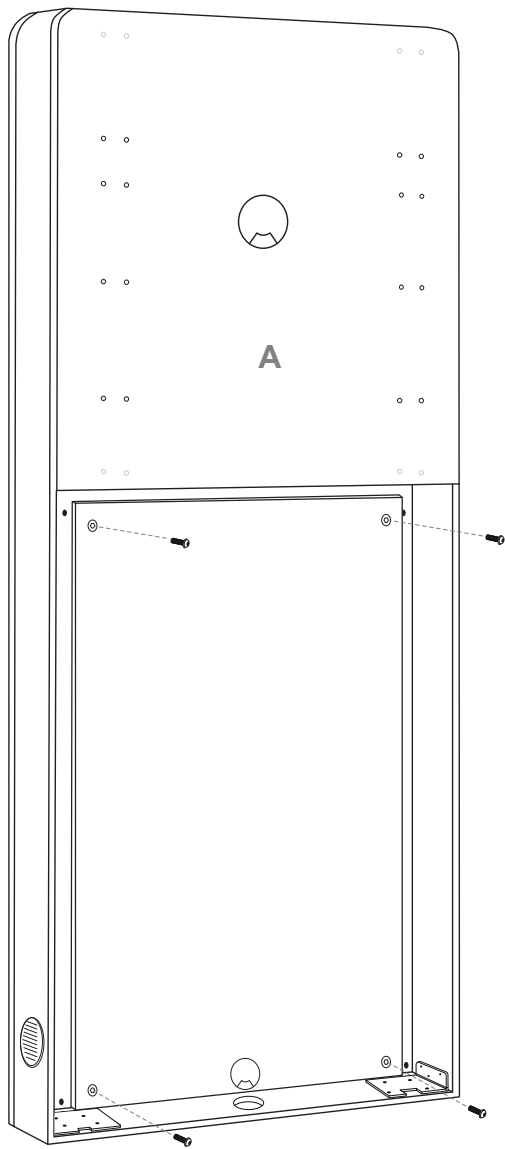
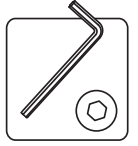

Verschraubung der Montageplatte von der Rückwand lösen.

Loosen the screw connection of the mounting plate from the rear panel.

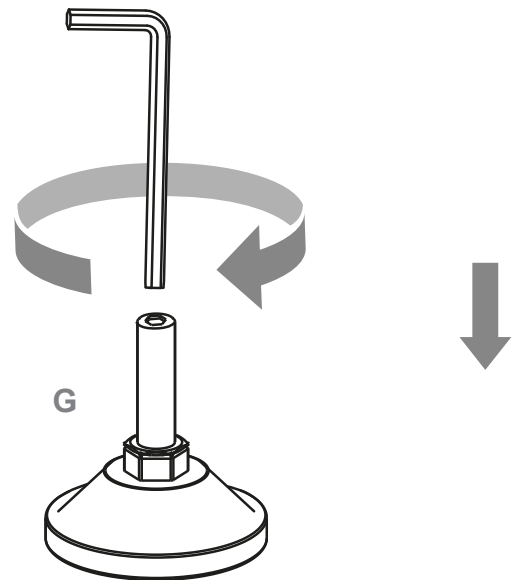
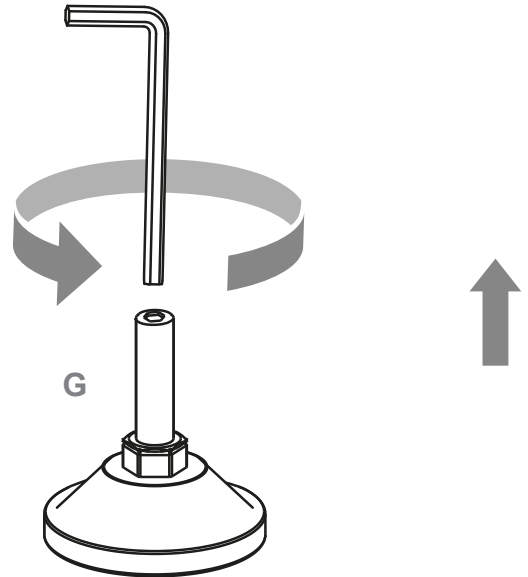
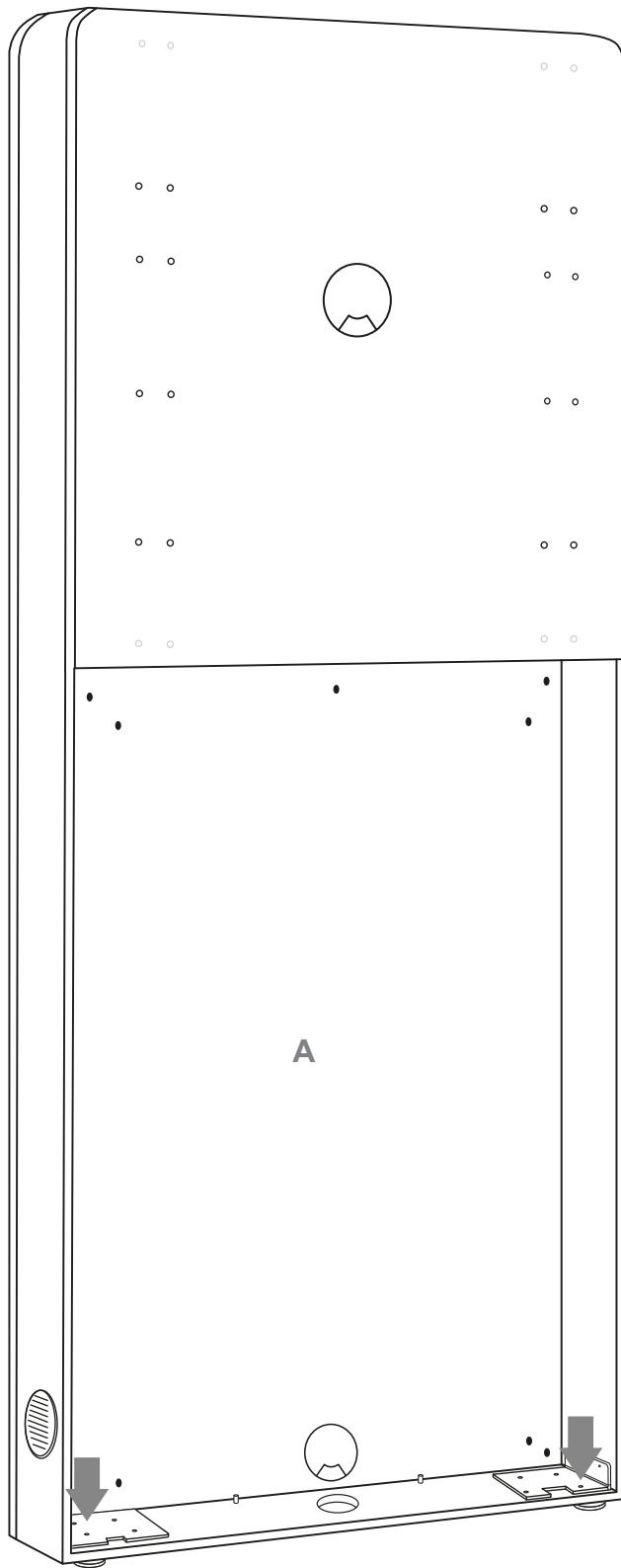
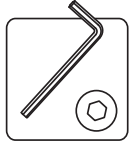

Richten Sie das Möbel aus indem Sie die Stellfüße (G - vormontiert) mit einem Inbusschlüssel herein- oder heraus drehen.

Align the corpus by turning the adjustable feet (G - pre-assembled) in or out with an Allen key.

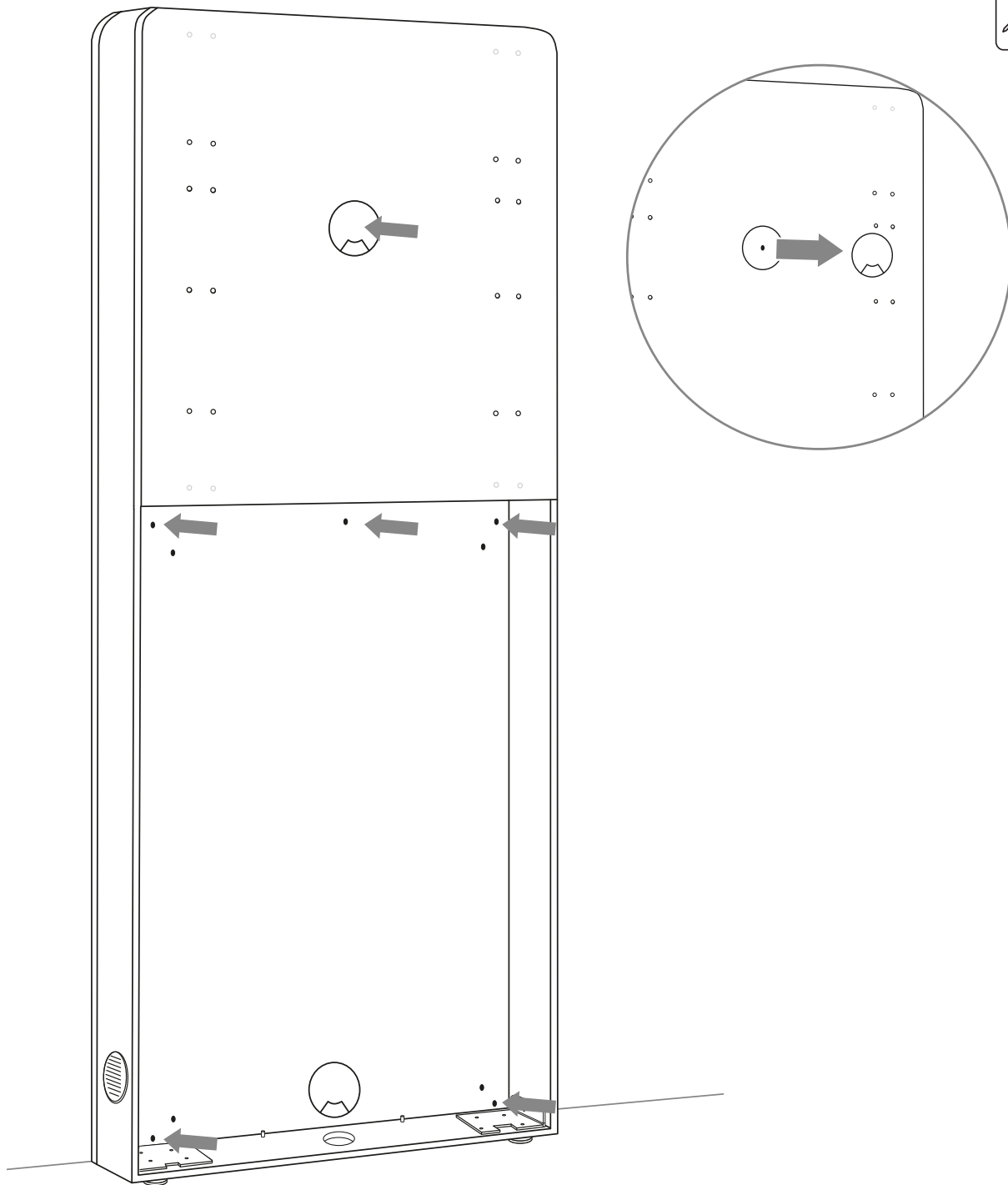

Montagematerial zur Wandmontage ist nicht im Lieferumfang enthalten. Verwenden Sie nur Montage-materialien, die für den Zweck und die Art der Wand geeignet sind. Prüfen Sie die Festigkeit der ver-wendeten Dübel und Schrauben. Wenn eine Fußleiste vorhanden ist, verwenden Sie bitte zusätzlich die Abstandshalter (N). Bei Leichtbauwänden empfehlen wir die Verwendung des zusätzlichen Montage-punktes. Entfernen Sie den oberen Kabeldurchlass um die Bohrung zu erreichen. Kabel z.B. zur Strom-versorgung sollten vor dem Aufrichten der Stele durch die Kabeldurchführungen im Boden des Korpus geführt werden.

Mounting material for wall mounting is not included in the scope of delivery. Use only mounting materials which is suitable for the purpose and type of wall. Check the strength of the anchors and screws you use. If there is a skirting board, please add the spacers (N). For wood stud walls, we recommend using the additional mounting point. Remove the top cable grommet to access the hole. Cables, such as those for power supplies, should be routed through the cable feedthrough in the base of the corpus before straighten the stele.

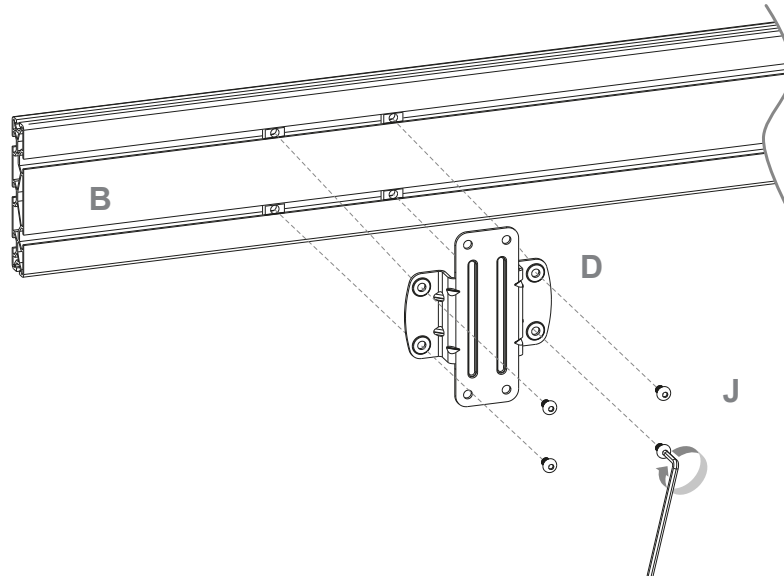
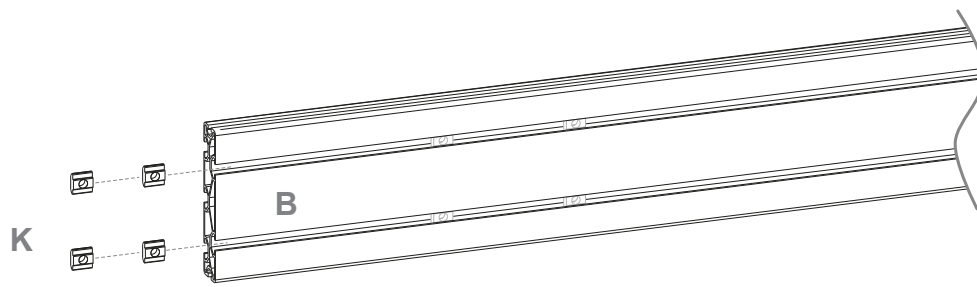

Ziehen Sie die Schrauben noch nicht ganz fest, damit ein nachjustieren der Position möglich ist.

Do not tighten the screws completely so that the position can be readjusted.

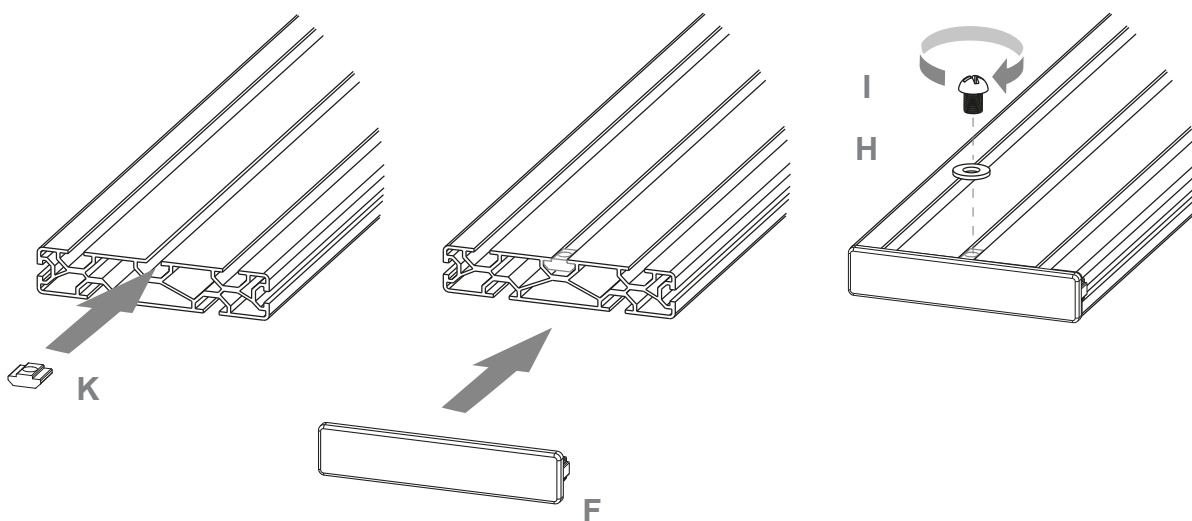

Die Nutensteine in die Schiene schieben, Kappen aufsetzen und beides festschrauben. Auf der anderen Seite ebenso.
Slide the slot nuts into the rail, put on the caps and screw both tight. On the other side as well.

7a

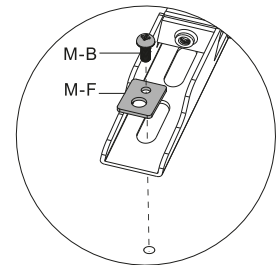
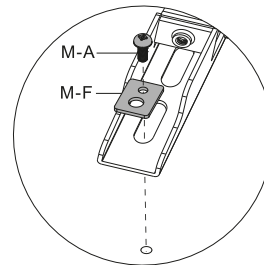
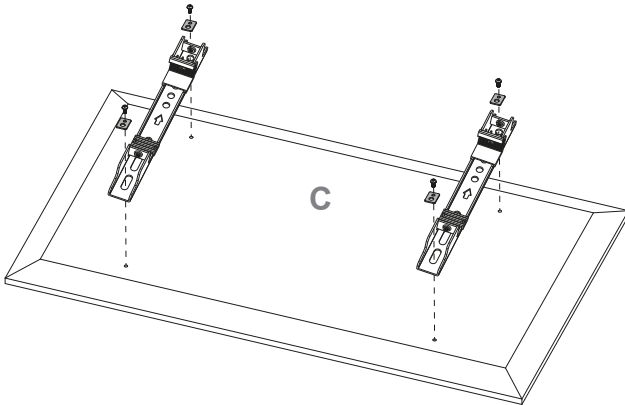
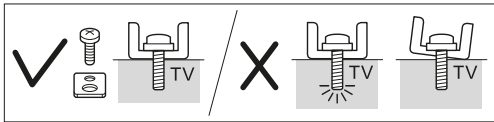

7b

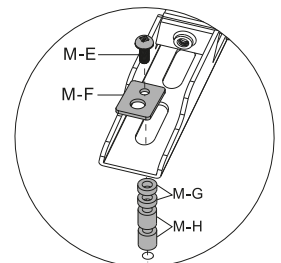
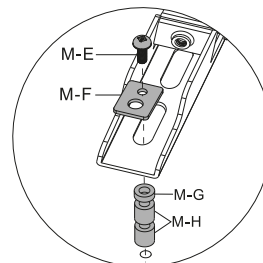
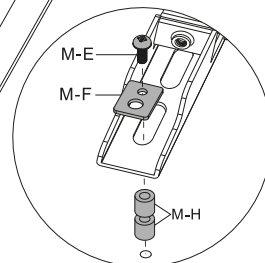
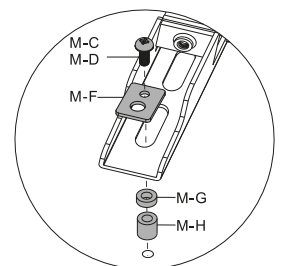
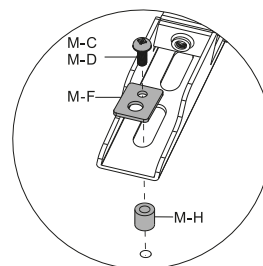
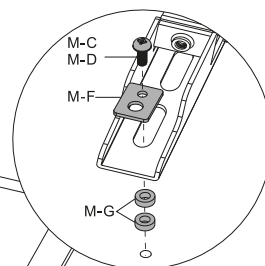
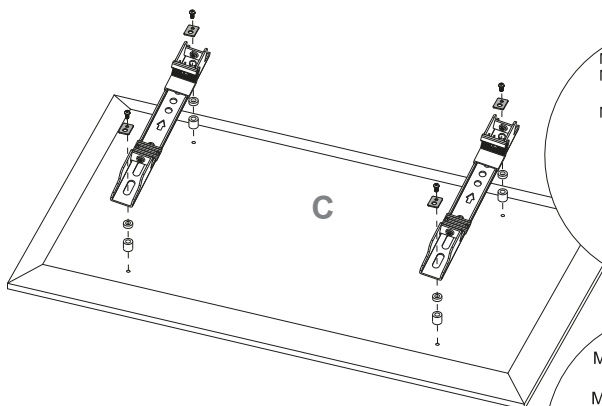
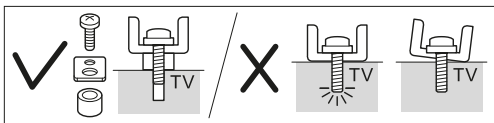

- Verwenden Sie für den Bildschirmtyp geeignete Schrauben, Unterlegscheiben und falls nötig Distanzscheiben.
- Zentrieren Sie die VESA-Arme wie in der Zeichnung gezeigt und schrauben sie sie fest. Schrauben nicht zu fest anziehen um Beschädigungen zu vermeiden.

- Choose the appropriate screws, washers and spacers (if necessary) according to the type of screen.
- Center the adapter brackets on the back of the display as shown, and screw the brackets onto the display, being sure to not over-tighten.

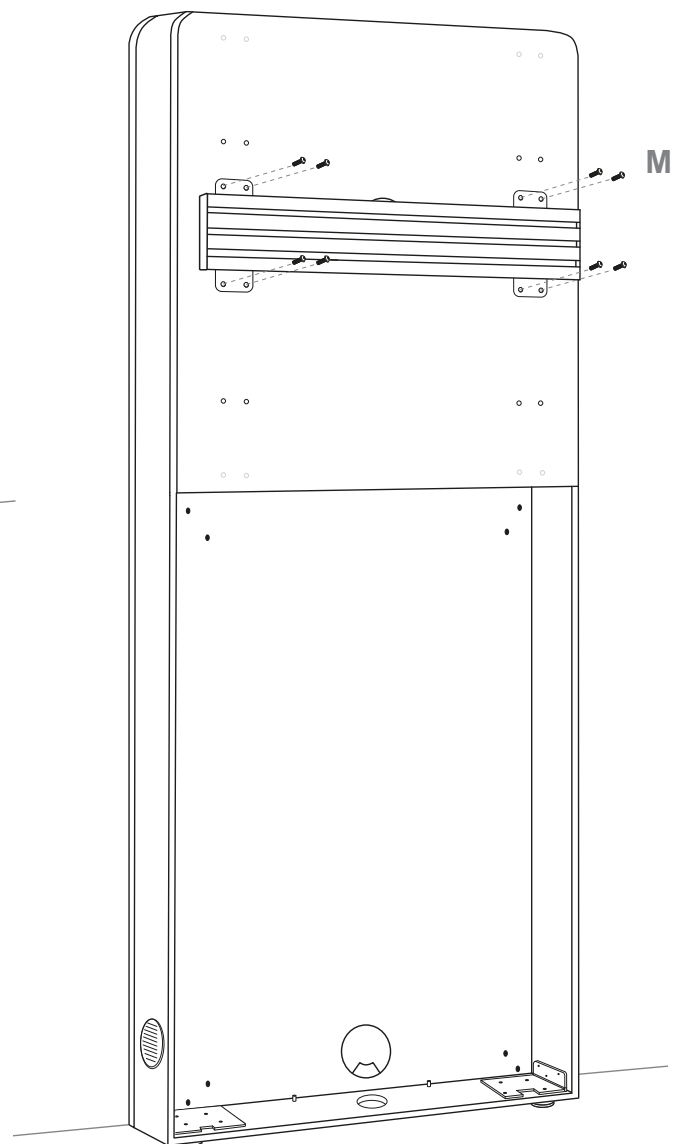
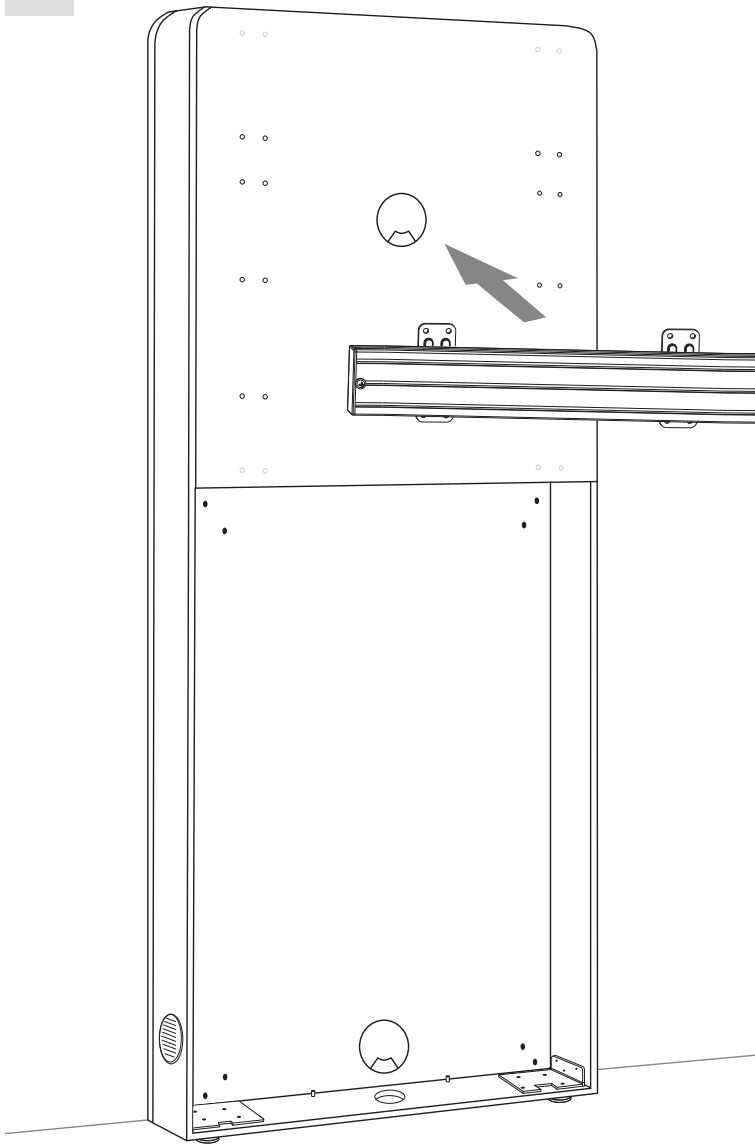
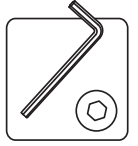

Die gewünschte Montagehöhe wird nach dem verwendeten Bildschirm ausgewählt.
Richten Sie die Schiene mittig aus und ziehen Sie die rückseitigen Schrauben jetzt richtig fest.

The desired mounting height is selected according to the used screen.
Align the rail centred and tighten the screws on the back properly now.

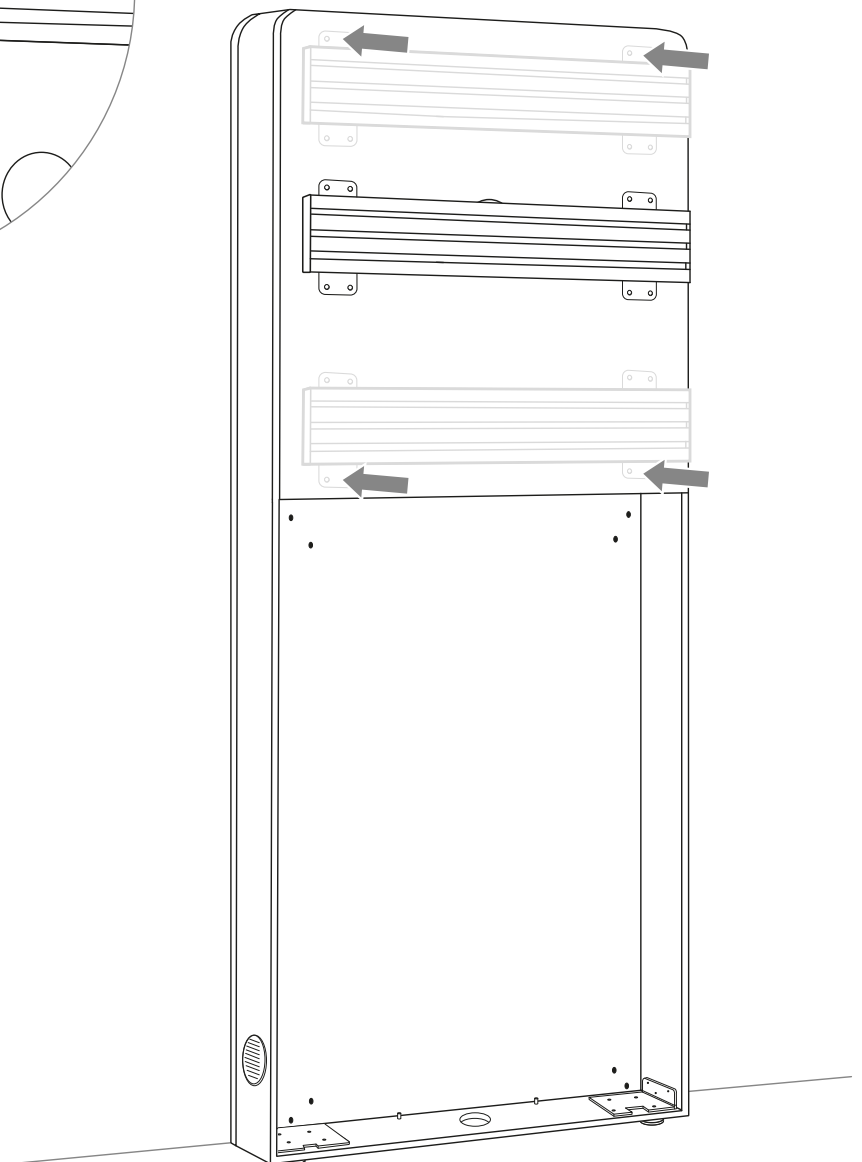
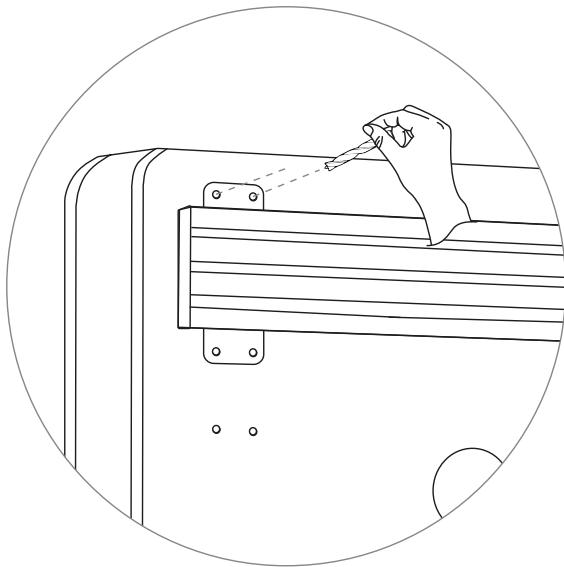

Zur Montage in der obersten oder untersten Montageposition, können die verdeckten Verschraubungspunkte, mit zum Beispiel einem 8er Holzbohrer, freigelegt werden. Nutzen Sie hierfür die Befestigungsadapter D als Schablone gemäß Abbildung.

For mounting in the top or bottom mounting position, the concealed screwing points can be uncovered, for example with a size 8 wood drill bit. To do this, use the fastening adapter D as a template as shown in the illustration.

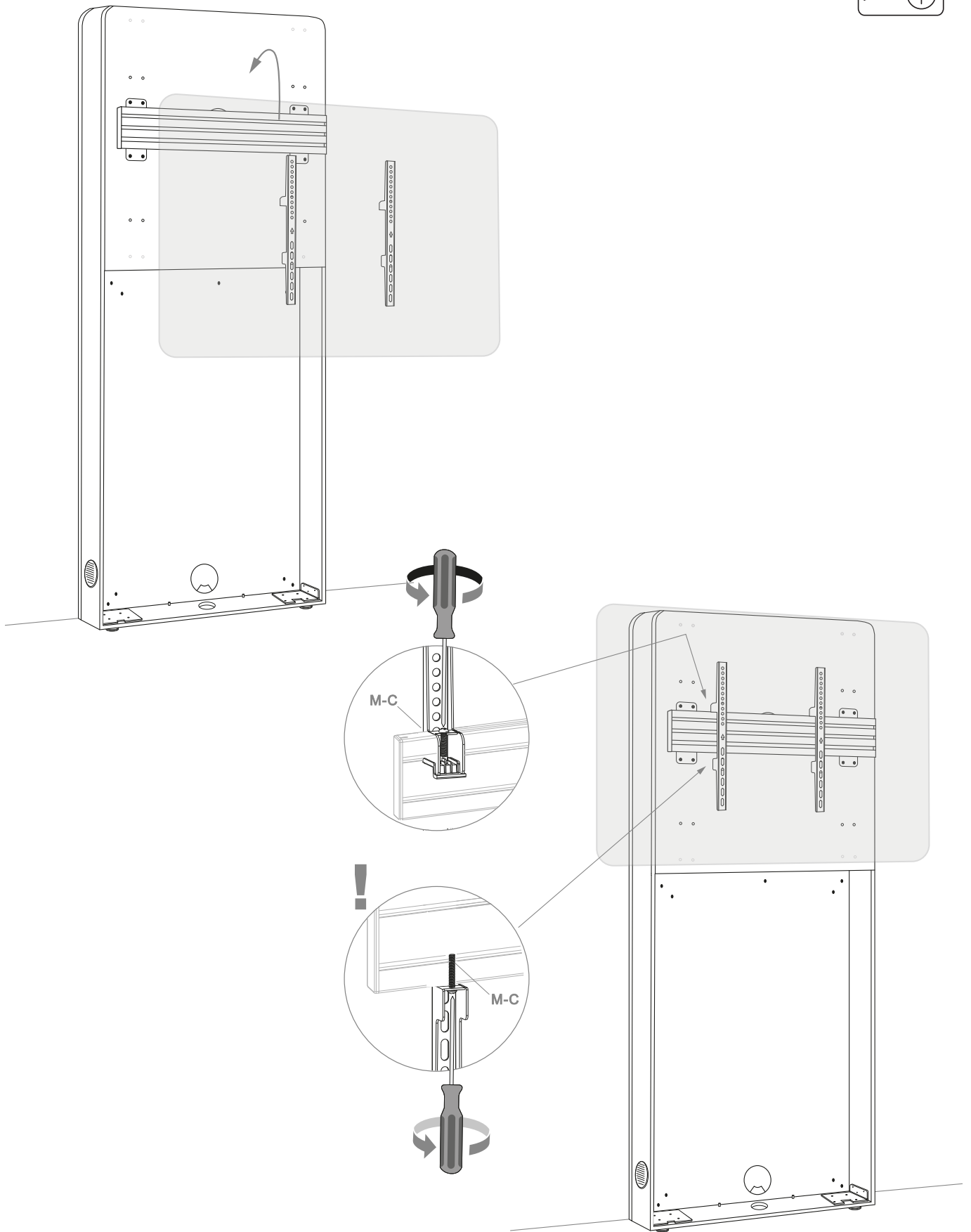

Hängen Sie den Bildschirm in die Halterung ein und ziehen Sie nach dem Ausrichten, die Sicherheitsschrauben fest.
Attach the screen to the bracket and after aligning, tighten the security screws.

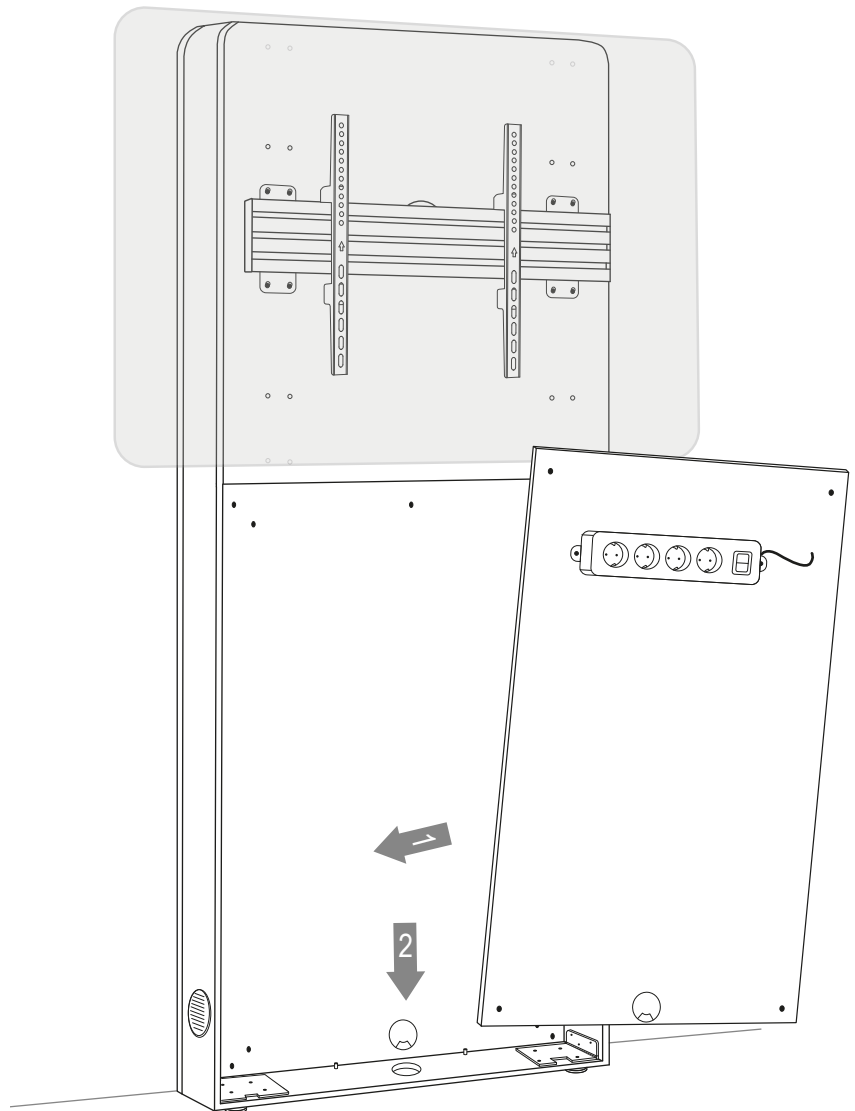
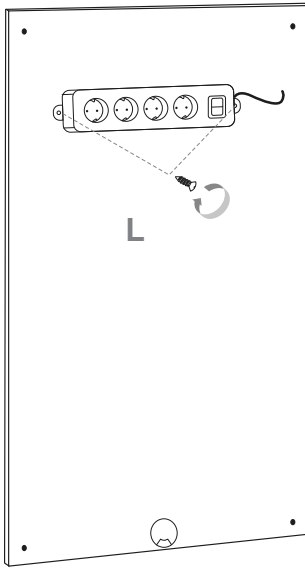

Positionieren Sie das benötigte AV-Zubehör frei, nach Ihren Wünschen, auf der Montageplatte.

Position the required AV accessories freely, according to your wishes, on the mounting plate.

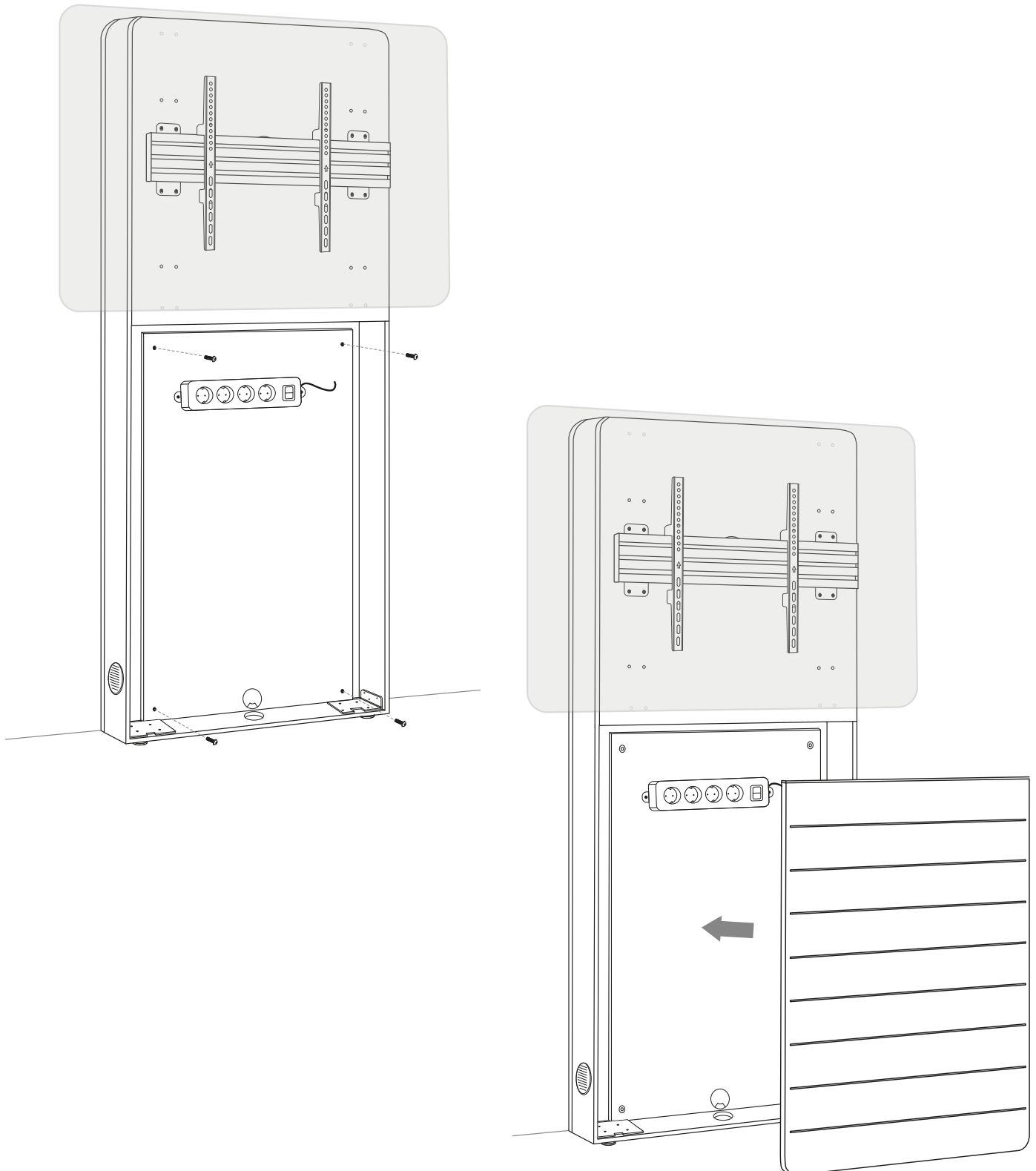

Verschrauben Sie die Montageplatte wieder an der Rückwand.

Abschließend wird die Frontblende wieder vorne am Korpus befestigt. Die Frontblende ist durch eine Magnetarretierung fixiert.

Screw the mounting plate back to the rear wall.

Finally, the front panel is attached to the front of the corpus again. The front panel is fixed by a magnet lock.

Abmessungen | Dimensions

